

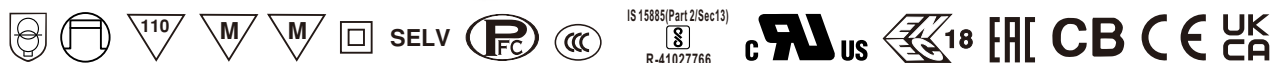

SILVAIR CASAMBI



■ Features

- Constant Current mode output with multiple levels selectable by dip switch
- Flicker free design
- Plastic housing with class II design
- Functions: Bluetooth low energy mesh Synchronization up to 10units
- 3 years warranty

■ Applications

- LED indoor lighting
- LED office lighting
- LED architectural lighting
- LED panel lighting
- LED commercial lighting
- Intelligent lighting control

■ Description

LCM-25 IoT series is a 25W AC/DC constant current mode output LED driver featuring the multiple levels selectable by dip switch and integration with Bluetooth control solution. LCM-25 IoT operates from 180~277VAC and offers different current levels ranging between 350mA and 1050mA. Thanks to the efficiency up to 84.5%, with the fanless design, the entire series is able to operate for -20°C~+85°C case temperature under free air convection. In addition, LCM-25 IoT is designed with synchronization Function, so as to provide the optimal design flexibility for LED lighting system and upgrade lighting to be an intelligent lighting system.

■ Model Encoding

LCM - 25 BLE

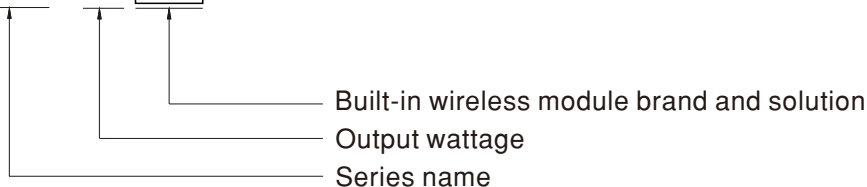

IoT wireless Module brand and solution

| Brand | Solution | Wireless standard | Note |
|---------|----------|---|------------|
| Casambi | BLE | Bluetooth low energy mesh 2.4GHz protocol | By request |
| Tuya | TY1 | Bluetooth low energy mesh 2.4GHz protocol | By request |
| Silvair | SVA | Bluetooth low energy mesh 2.4GHz protocol | By request |



SPECIFICATION

| | | | | | | | |
|-------------------------|--|---|---------|---------|----------------|---------|---------|
| MODEL | | LCM-25 □ | | | | | |
| OUTPUT | CURRENT LEVEL | Current level selectable via DIP switch, please refer to "DIP SWITCH TABLE" section | | | | | |
| | | 350mA | 500mA | 600mA | 700mA(default) | 900mA | 1050mA |
| | RATED POWER | 18.9W | 25.2W | | | | |
| | DC VOLTAGE RANGE | 6 ~ 54V | 6 ~ 50V | 6 ~ 42V | 6 ~ 36V | 6 ~ 28V | 6 ~ 24V |
| | OPEN CIRCUIT VOLTAGE (max.) | 59V | | | 41V | | |
| | CURRENT RIPPLE | 5.0% max. @rated current | | | | | |
| | CURRENT TOLERANCE | ±5% | | | | | |
| INPUT | VOLTAGE RANGE Note.2 | 180 ~ 277VAC 254 ~ 380VDC (Please refer to "STATIC CHARACTERISTIC" section) | | | | | |
| | FREQUENCY RANGE | 47 ~ 63Hz | | | | | |
| | POWER FACTOR (Typ.) | PF ≥ 0.94/230VAC, PF ≥ 0.91/277VAC@full load (Please refer to "POWER FACTOR (PF) CHARACTERISTIC" section) | | | | | |
| | TOTAL HARMONIC DISTORTION | THD < 20% (@load ≥ 50%/230VAC; @load ≥ 75%/277VAC) (Please refer to "TOTAL HARMONIC DISTORTION (THD)" section) | | | | | |
| | EFFICIENCY (Typ.) Note.4 | 84.5% | | | | | |
| | AC CURRENT (Typ.) | 0.17A/230VAC 0.15A/277VAC | | | | | |
| | INRUSH CURRENT (Typ.) | COLD START 20A(twidth=260μs measured at 50% Ipeak) at 230VAC; Per NEMA 410 | | | | | |
| | MAX. No. of PSUs on 16A CIRCUIT BREAKER | 26 units (circuit breaker of type B) / 44 units (circuit breaker of type C) at 230VAC | | | | | |
| | LEAKAGE CURRENT | <0.5mA / 240VAC | | | | | |
| | STANDBY POWER CONSUMPTION Note.8 | <1W | | | | | |
| PROTECTION | SHORT CIRCUIT | Constant current limiting, recovers automatically after fault condition is removed | | | | | |
| | OVER TEMPERATURE | Shut down o/p voltage, recovers automatically after temperature goes down | | | | | |
| FUNCTION | WIRELESS PROTOCOL | Bluetooth low energy 2.4GHz protocol | | | | | |
| | DIMMING RANGE Note.9 | 0~100% Minimum dimming level:6%, dim to off | | | | | |
| | SYNCHRONIZATION | Please refer to "SYNCHRONIZATION OPERATION" section | | | | | |
| ENVIRONMENT | WORKING TEMP. | Tcase=-20 ~ +85°C (Please refer to "OUTPUT LOAD vs TEMPERATURE" section) | | | | | |
| | MAX. CASE TEMP. | Tcase=+85°C | | | | | |
| | WORKING HUMIDITY | 20 ~ 90% RH non-condensing | | | | | |
| | STORAGE TEMP., HUMIDITY | -40 ~ +80°C, 10 ~ 95% RH | | | | | |
| | TEMP. COEFFICIENT | ±0.03%/°C (0 ~ 50°C) | | | | | |
| | VIBRATION | 10 ~ 500Hz, 2G 10min./1cycle, period for 60min. each along X, Y, Z axes | | | | | |
| SAFETY & EMC | SAFETY STANDARDS | UL8750(except for DA2-Type), CSA C22.2 NO.250.0-08, ENEC BS EN/EN61347-1, BS EN/EN61347-2-13, BS EN/EN62384 independent, GB19510.14, GB19510.1, BIS IS15885, EAC TP TC 004 approved | | | | | |
| | WITHSTAND VOLTAGE | I/P-O/P:3.75KVAC | | | | | |
| | ISOLATION RESISTANCE | I/P-O/P:>100M Ohms / 500VDC / 25°C / 70% RH | | | | | |
| | EMC EMISSION Note.6 | Compliance to BS EN/EN55015, BS EN/EN61000-3-2 Class C (@load ≥ 50%); BS EN/EN61000-3-3; GB17625.1, GB17743, EAC TP TC 020 | | | | | |
| | EMC IMMUNITY | Compliance to BS EN/EN61000-4-2,3,4,5,6,8,11, BS EN/EN61547, light industry level(surge immunity Line-Line 2KV), EAC TP TC 020 | | | | | |
| OTHERS | MTBF | 213.3K hrs min. MIL-HDBK-217F (25°C) | | | | | |
| | DIMENSION | 105*68*23mm (L*W*H) | | | | | |
| | PACKING | 0.17Kg ; 72pcs/13.2Kg/1.04CUFT | | | | | |
| NOTE | <ol style="list-style-type: none"> All parameters NOT specially mentioned are measured at 230VAC input, rated current and 25°C of ambient temperature. De-rating may be needed under low input voltages. Please refer to "STATIC CHARACTERISTIC" sections for details. Length of set up time is measured at first cold start. Turning ON/OFF the driver may lead to increase of the set up time. Efficiency is measured at 500mA/50V output set by DIP switch. Standby power consumption is measured at 230VAC. The driver is considered as a component that will be operated in combination with final equipment. Since EMC performance will be affected by the complete installation, the final equipment manufacturers must re-qualify EMC Directive on the complete installation again. The ambient temperature derating of 3.5°C/1000m with fanless models and of 5°C/1000m with fan models for operating altitude higher than 2000m(6500ft). The standby power consumption does not need to meet ErP due to the integrated wireless transmitter which is working all the time. The dimming memory function needs at least 5 seconds to complete. The matching mode of TY1 type is on-off-on-off-on by AC or DC power To fulfill requirements of the latest ErP regulation for lighting fixtures, this LED power supply can only be used behind a switch without permanently connected to the mains. <p>※ Product Liability Disclaimer : For detailed information, please refer to https://www.meanwell.com/serviceDisclaimer.aspx</p> | | | | | | |

■ BLOCK DIAGRAM

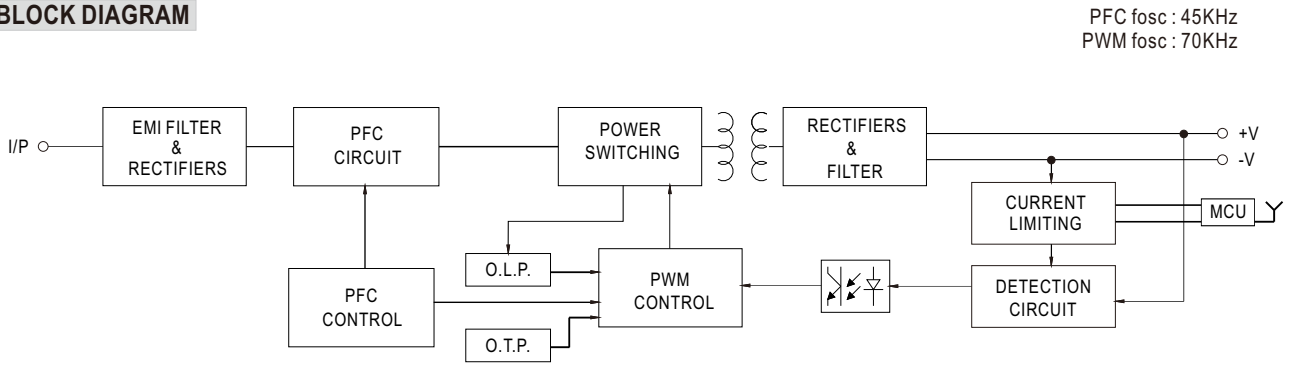

■ DIP SWITCH TABLE

• LCM-25 IoT series is a multiple-stage constant current driver, selection of output current through DIP switch is exhibited below.

| DIP S.W. | 1 | 2 | 3 | 4 | 5 | 6 |
|------------------------|------|------|------|------|------|------|
| 350mA | ---- | ---- | ---- | ---- | ---- | ---- |
| 500mA | ON | ---- | ---- | ---- | ---- | ---- |
| 600mA | ON | ON | ---- | ---- | ---- | ---- |
| 700mA(factory default) | ON | ON | ON | ---- | ---- | ON |
| 900mA | ON | ON | ON | ON | ---- | ON |
| 1050mA | ON | ON | ON | ON | ON | ON |

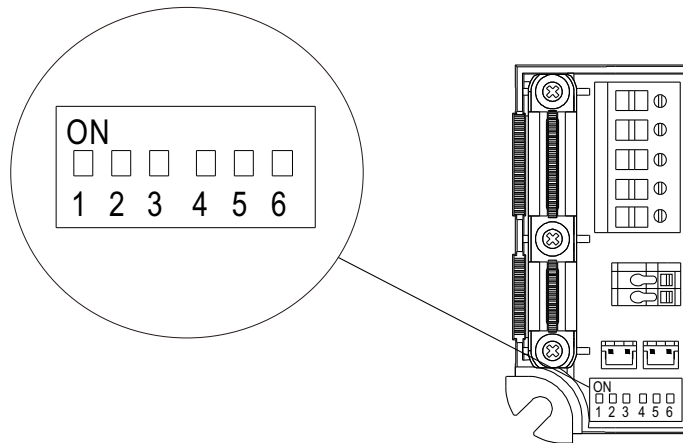

NOTE: For more output current is selectable, please contact MEANWELL for details

DIMMING OPERATION

※Bluetooth control

- To be used through APP available on Apple Store and Google Play Store for iOS and Android.
Search: BLE with Casambi/TY1 with Smart Life/SVA with Silvair
Example:



The APP for BLE type is "Casambi" The APP for TY1 type is "Smart Life" The APP for SVA type is "Silvair"

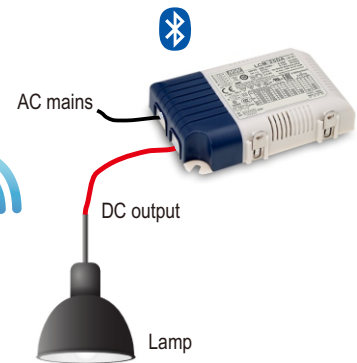
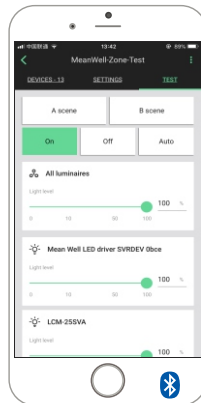
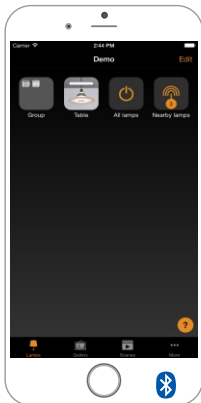

OFFICIAL WEBSITE AND ECOSYSTEM INFORMATION

CASAMBI

The real time Bluetooth IC temperature is shown in the APP. In case it reaches above 72 °C (equivalent to Tc 85°C), the driver will be turn off to provide a protection. In case the units is cooled down, it can be manually turn ON and back to normal operation again.

NOTE: 1.This software temperature protection is an extra independent function from driver its own hardware over temperature protection(when it is enabled, it needs re-AC power on to recover).

2.In general the software temperature protection is triggered before the hardware one when in over temperature.

3.Website: <https://www.casambi.com>



NOTE: 1.Website: <https://www.tuya.com>

SILVAIR

NOTE: 1.Website: <https://www.silvair.com>

■ PUSH DIMMING FUNCTION

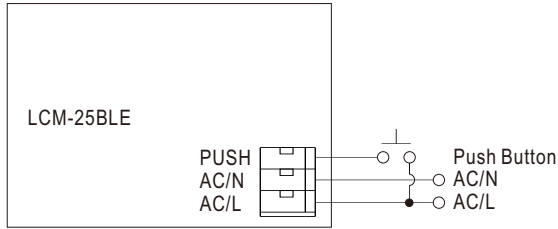

※Freely assignable (push) input(Push dimming function only for BLE)

- The LCM BLE series also has one freely assignable AC mains (push) input. As with a CASAMBI sensor module, control pulses can be defined here (e.g. “controls a luminaire”; “controls an element”; “controls a group”; “controls scenes”; “controls all luminaires”; “change scenes”). See the reference connection figure in the above.

■ SYNCHRONIZATION OPERATION

- Synchronization up to 10 drivers (1 master + 9 slaves)
- Dimming operating range : 10%~100%
- Sync cable length : < 5m
- Sync cable type : Flat cable
- Sync cable cross section area : 22 – 24 AWG (0.2~0.3mm²)

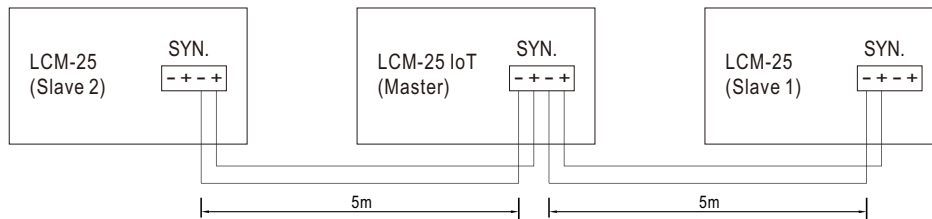

- NOTE: 1. Please make sure all units are set to 100% dimming setting (factory default) before synchronizing.
 2. Min. Dimming operating range depends on dimmer setting.

OUTPUT LOAD vs TEMPERATURE

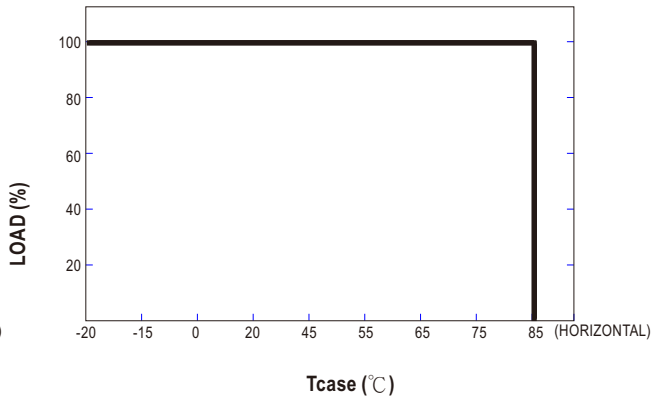
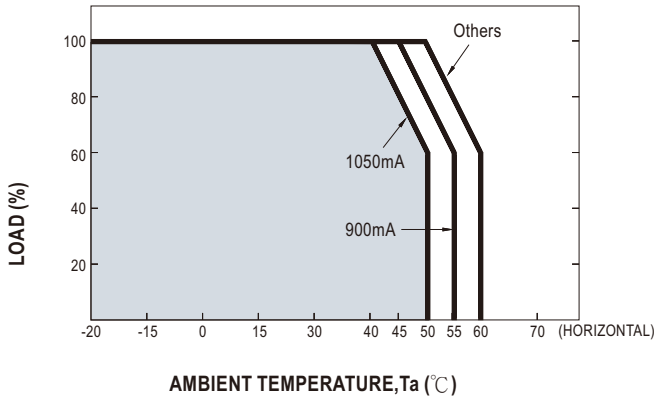

STATIC CHARACTERISTIC

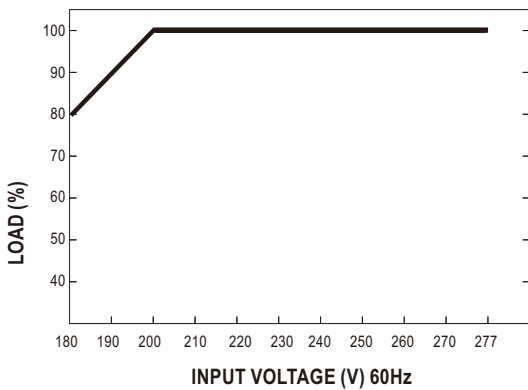

※ De-rating is needed under low input voltage.

Bluetooth mesh LED driver for intelligent lighting Application

LCM-25/40/60 Series
Multi-Dimming Function LED Driver and Wireless IoT Solutions

- 0-10V
- PWM
- Resistance
- Push Dimming
- DALI / DALI 2.0
- EnOcean
- KNX
- PIR
- Bluetooth Mesh
- WiFi.....and so on

3rd Party APPs | APP | Gateway Roture | APP | Building Lighting with IoT Bluetooth Mesh Solution

TOTAL HARMONIC DISTORTION (THD)

※ Tcase at 75°C

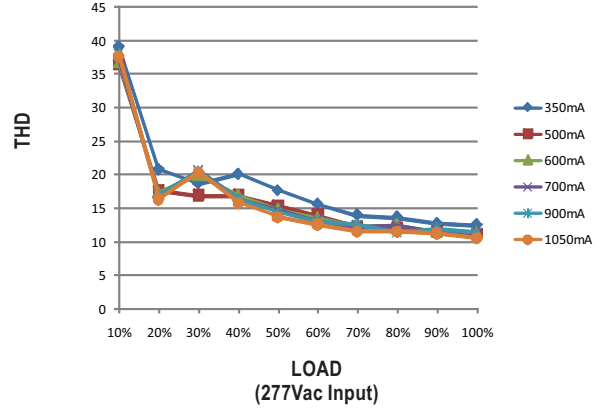
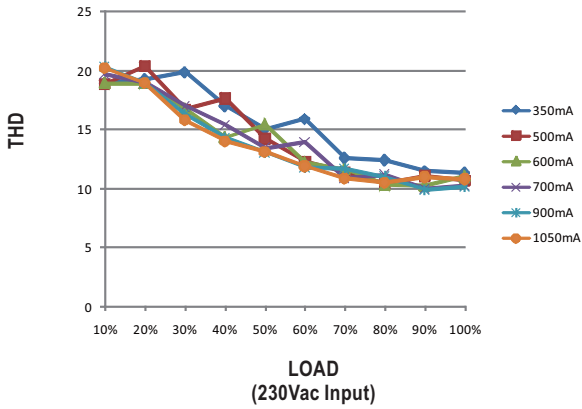

POWER FACTOR (PF) CHARACTERISTIC

※ Tcase at 75°C

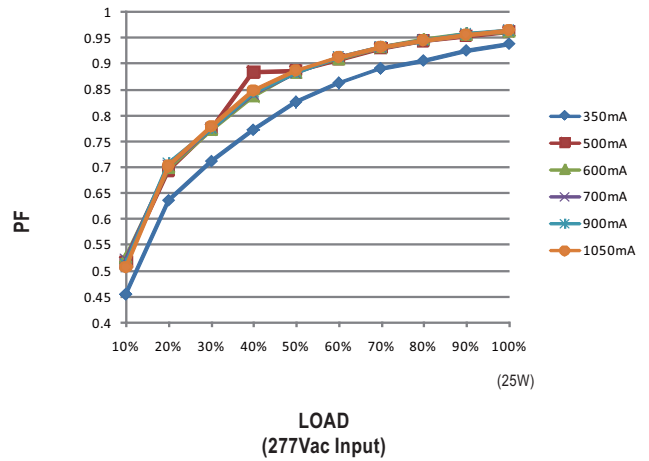
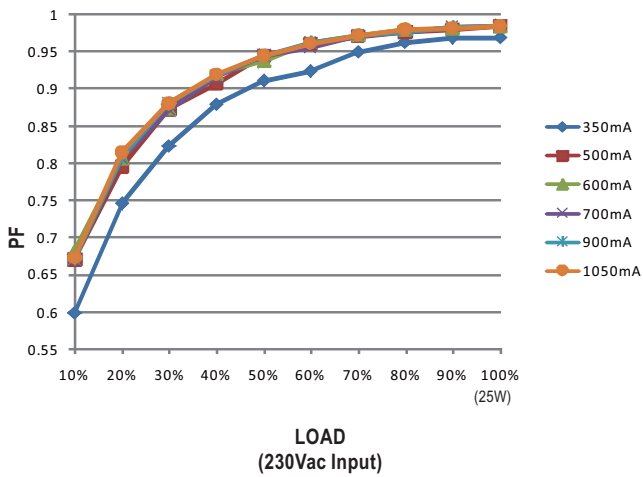

EFFICIENCY vs LOAD

LCM-25 IoT series possess superior working efficiency that up to 84.5% can be reached in field applications.

※ Tcase at 75°C

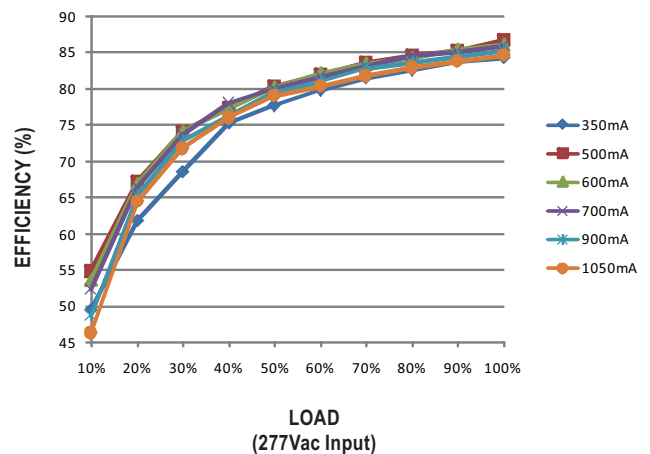
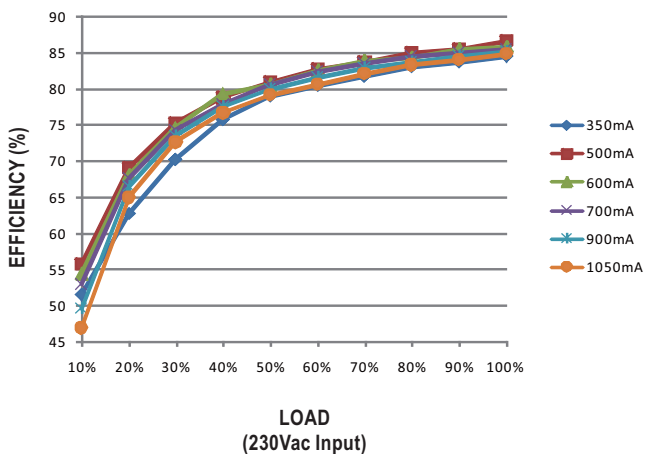

MECHANICAL SPECIFICATION

Case No.LCM-25 Unit:mm

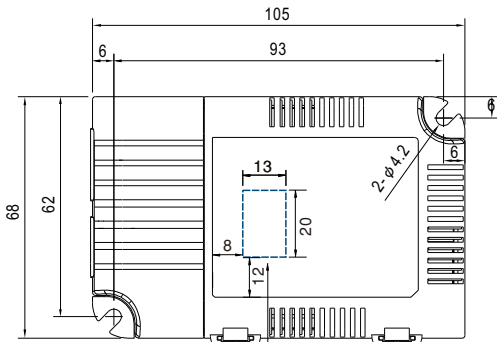

The position of antenna
Keep it free from metal or
any material that stops RF signal

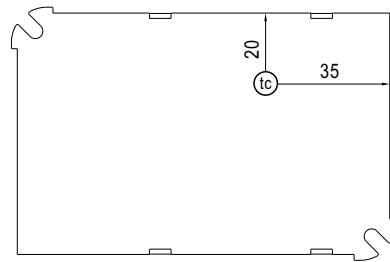
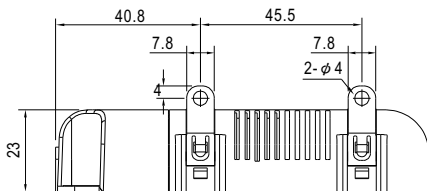
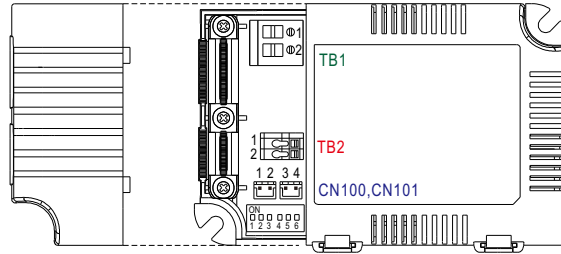

Bottom View

• (tc) : Max. Case Temperature <85°C

※ Terminal Pin No. Assignment(TB1)(Input)

| Pin No. | Assignment |
|---------|----------------|
| 1 | AC/L |
| 2 | AC/N |
| 3 | PUSH(BLE only) |

※ Terminal Pin No. Assignment(TB2) (Output)

| Pin No. | Assignment |
|---------|------------|
| 1 | +V |
| 2 | -V |

※ SYN. Connector(CN100/CN101):

| Pin No. | Assignment | Mating Housing | Terminal |
|---------|------------|----------------------------|-------------------------------------|
| 1, 3 | - | JST PHR-2 or equivalent | JST SPH-002T-P0.5S or equivalent |
| 2, 4 | + | | |

Note:Please use wires with a cross section of 0.5~2.5mm²(14~20AWG) for TB1 and wires with a cross section of 0.5~1.5 mm²(16~20AWG) for TB2.
Please use wires with a cross section of 0.126~0.205mm²(24~26AWG) for CN100/CN101

INSTALLATION MANUAL

Please refer to : <http://www.meanwell.com/manual.html>